

Breville®

Breville Customer Service Centre

Australian Customers

Mail: Locked Bag 2000
Botany NSW 1455
AUSTRALIA

Phone: 1300 139 798

Fax: (02) 9700 1342

Email: Customer Service:
askus@breville.com.au

New Zealand Customers

Mail: Private Bag 94411
Botany Manukau 2163
Auckland NEW ZEALAND

Phone: 0800 273 845

Fax: 0800 288 513

Email: Customer Service:
askus@breville.co.nz

www.breville.com.au

www.breville.co.nz

Breville is a registered trademark of Breville Pty. Ltd. A.B.N. 98 000 092 928.
Copyright Breville Pty. Ltd. 2015.

Due to continued product improvement, the products illustrated/photographed
in this brochure may vary slightly from the actual product.

BES920 Issue - J15

Breville®

the Dual Boiler™

Instruction Booklet



BES920

CONGRATULATIONS

on the purchase of your new
Breville product

CONTENTS

- 4** Breville recommends safety first
- 8** Know your Breville product
- 10** Operating your Breville product
- 20** Coffee making tips & preparation
- 23** Care & cleaning
- 27** Troubleshooting
- 32** Coffees to try

At Breville we are very safety conscious. We design and manufacture consumer products with the safety of you, our valued customer, foremost in mind. In addition we ask that you exercise a degree of care when using any electrical appliance and adhere to the following precautions.

IMPORTANT SAFEGUARDS

FOR ALL ELECTRICAL APPLIANCES

- Carefully read all instructions before operating and save for future reference.
- Remove any packaging material and promotional labels or stickers before using the appliance for the first time.
- To eliminate a choking hazard for young children, remove and safely discard the protective cover fitted to the power plug of this appliance.
- Do not place the product near the edge of a bench or table during operation. Ensure the surface is level, clean and free of water and other substances.
- Do not let the cord hang over the edge of a bench or table, or become knotted. Keep away from hot gas or electric burner, or where it could touch a heated oven.
- This appliance can be used by children aged from 8 years and above if they have been given supervision or instruction concerning use of the appliance in a safe way and understand the hazards involved. Cleaning and user maintenance shall not be made by children unless they are aged from 8 years and above and supervised. Keep the appliance and its cord out of reach of children aged less than 3 years.
- Appliances can be used by persons with reduced physical, sensory or mental capabilities or lack of experience and knowledge if they have been given supervision or instruction concerning use of the appliance in a safe way and understand the hazards involved.
- Children shall not play with the appliance.
- Regularly inspect the supply cord, plug and actual appliance for any damage. If found damaged in any way, immediately cease use of the appliance and return the entire appliance to the nearest authorised Breville Service Centre for examination, replacement or repair.
- Keep the appliance and accessories clean. Follow the cleaning instructions provided in this book. Any procedure not listed in this instruction booklet should be performed at an authorised Breville Service Centre.
- The installation of a residual current device (safety switch) is recommended to provide additional safety protection when using electrical appliances. It is advisable that a safety switch with a rated residual operating current not exceeding 30mA be installed in the electrical circuit supplying the appliance. See your electrician for professional advice.

SPECIFIC INSTRUCTIONS FOR BES920 DUAL BOILER

- This appliance is recommended for household use only. Do not use this appliance for other than its intended use. Do not use in moving vehicles or boats. Do not use outdoors.
- If the appliance is to be:
 - left unattended
 - cleaned
 - moved
 - assembled; or
 - stored
 always switch Off the espresso machine by pressing the Power button to Off, switch Off at the power outlet and unplug.
- Ensure the product is properly assembled before first use.
- Do not use any other liquid apart from cold mains/town water. We do not recommend the use of highly filtered, de-mineralised or distilled water as this may affect the taste of the coffee and how the espresso machine is designed to function.
- Ensure the portafilter is firmly inserted and secured into the group head before starting an extraction. Never remove the portafilter during the brewing process.
- Do not leave the product unattended when in use.
- Do not touch hot surfaces. Allow the product to cool down before moving or cleaning any parts.
- Use caution when operating machine as metal surfaces are liable to get hot during use.
- Use caution when using the de-scale feature as hot steam may be released. Before de-scaling, ensure drip tray is inserted. Refer to 'Care & Cleaning' for further instructions.

SAVE THESE INSTRUCTIONS

TRIPLE HEAT SYSTEM

Dual Stainless Steel Boilers

Dedicated espresso and steam boilers for simultaneous milk texturing and espresso extraction at the optimum temperature.

Actively Heated Group Head

Commercial 58mm group head with embedded element for optimal thermal stability during extraction.

PRECISION CONTROL

Electronic PID Temperature Control

Electronic temperature control delivers precise water temperature to +/- 1°C for optimum espresso flavour. Programmable.

Regulated Extraction Pressure

Over pressure valve (OPV) limits maximum pressure for optimal espresso flavour.

Low Pressure Pre-Infusion

Gradually increases water pressure to gently expand grinds for an even extraction. Programmable.

Dual Pumps

Dedicated espresso and steam boiler pumps help maintain constant pressure throughout extraction.

Programmable Shot Temp

Allows user to adjust water temperature to achieve optimal espresso flavour.

ADDITIONAL FEATURES

LCD Interface

Displays current settings and simplifies programming functions.

High Volume Instant Steam

Dedicated 950ml steam boiler delivers instant and continuous steam.

Commercial Steam Wand

Stainless steel 360° swivel-action steam wand with 3 hole tip for a silkier texture.

Volumetric Control

Manual or programmed 1 & 2 cup shot volumes. Programmable for either duration or volume.

Instant Hot Water

Dedicated Hot Water outlet for making long blacks or pre-heating cups.

58mm Full Stainless Steel Portafilter

Helps to promote a more even extraction and is easier to clean.

Shot Clock

Displays duration of the espresso shot being extracted.

KNOW YOUR BREVILLE PRODUCT

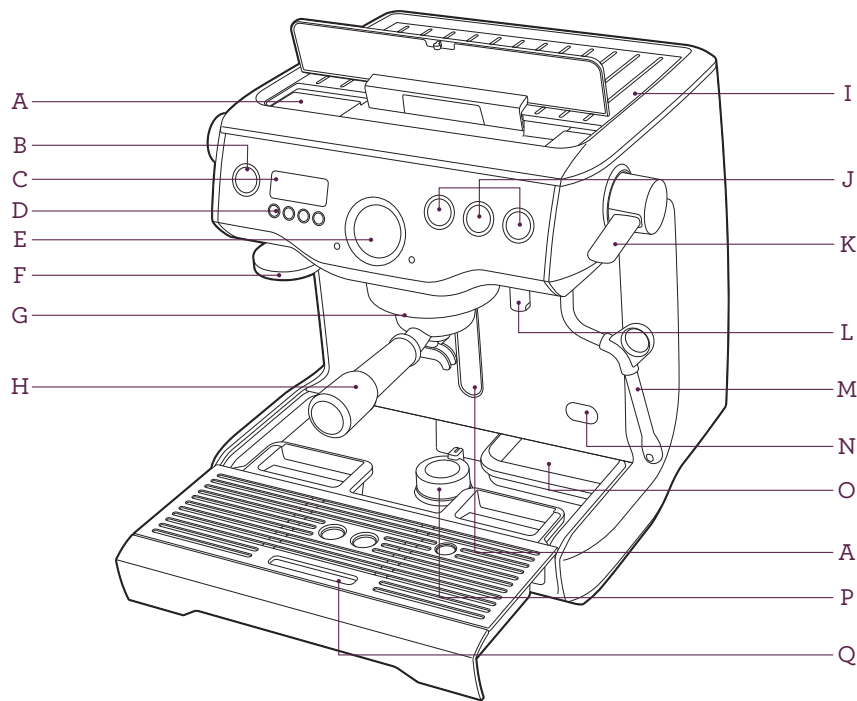

- A. Top fill 2.5 litre removable water tank with integrated water filter and backlit level indicator.
- B. **POWER** button
- C. **Backlit LCD interface** displays current settings and simplifies programming functions.
- D. **MENU** access and **DISPLAY** mode buttons
- E. **Espresso pressure gauge** monitors extraction pressure.
- F. **Integrated & removable 58mm tamper**
- G. **Actively heated 58mm group head with embedded element** for thermal stability during extraction.
- H. **58mm full stainless steel portafilter**
- I. **Convection heated 6 cup warming tray**
- J. **Manual and programmable 1 & 2 cup volume controls**
- K. **Easy to operate steam lever** for instant and continuous steam.
- L. **Dedicated hot water outlet** delivers instant hot water for long blacks & pre-heating cups.
- M. **360° swivel action steam wand with 3 hole tip** for a silkier texture.
- N. **De-scale access point**
- O. **Integrated tool storage tray**
- P. **Drop down swivel foot** for easy manoeuvrability.
- Q. **Removable drip tray with Empty Me!** indicator.

NOT SHOWN

15 bar Italian pump
 Dual stainless steel boilers
 Electronic PID temperature control
 Over pressure valve
 Low pressure pre-infusion
 Safety thermal cut-out protection

KNOW YOUR BREVILLE PRODUCT

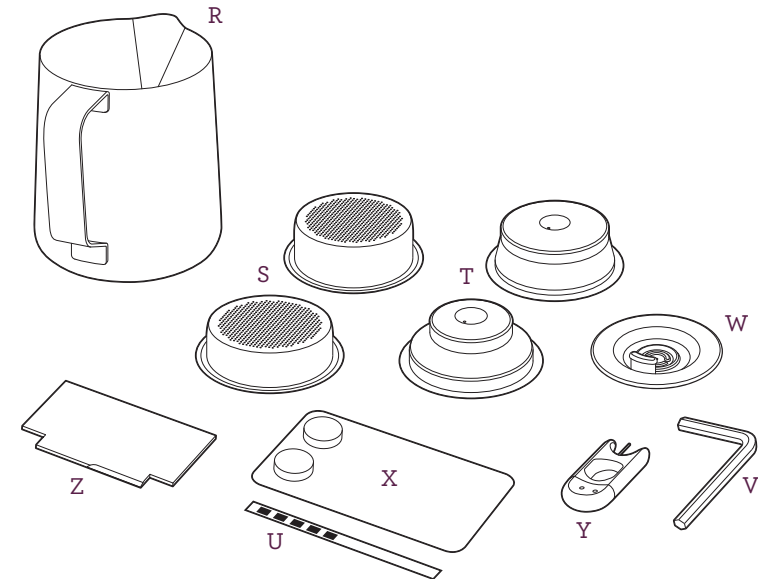

ACCESSORIES

- R. **Stainless steel frothing jug**
- S. **Single wall filter baskets (1 & 2 cup)**
- T. **Dual wall filter baskets (1 & 2 cup)**
- U. **Water hardness test strip**
- V. **Allen key**
- W. **Cleaning disc**
- X. **Espresso cleaning tablets**
- Y. **Cleaning tool**
- Z. **Razor™ precision dosing tool**

LCD INTERFACE

Display Modes

- Shot Temp
- Shot Clock Timer
- Clock

Programmable Functions

- Shot Temp
- Shot Volume - 1 & 2 cup
- Pre-Infusion
- Auto Start

⚠ WARNING

Both the **STEAM LEVER** and **HOT WATER dial** must be in the **CLOSED** position for the machine to enter **START UP mode**.

BEFORE FIRST USE

Machine Preparation

Remove and discard all labelling and packaging materials attached to your espresso machine. Ensure you have removed all parts and accessories before discarding the packaging.

Clean parts and accessories (water tank, portafilter, filter baskets, jug) using warm water and a gentle dish washing liquid and rinse well.

The water filter located inside the water tank will need to be removed before washing the water tank.

Conditioning the Water Filter

- Remove filter from the plastic bag and soak in a cup of water for 5 minutes.
- Rinse filter under cold running water.
- Wash the stainless steel mesh in the plastic filter compartment with cold water.
- Insert the filter into the filter holder.
- Set Date Dial 2 months ahead.
- To install filter, push down to lock into place.
- Slide the water tank into position and lock into place.

NOTE

To purchase filters contact Breville Customer Service Centre
 AUS 1300 139 798 NZ 0800 273 845
 or visit www.breville.com.au

FIRST USE

Initial Start Up

- Fill tank with cold tap water.
- Dip Water Hardness Test Strip into water tank for 1 second & set aside.
- Check Steam Lever and Hot Water dial are in the **CLOSED** position.
- Press **POWER** On.
- A pumping sound will be heard indicating empty boilers are being filled with water for the first time.
- Machine will prompt you to set water hardness. Refer to test strip for your water hardness. Use the **Arrow UP** or **Arrow DOWN** keys to select water hardness 1-5. Press **Menu** to set. Machine will beep to confirm selection.
- Machine will reach operating temperature and go into **STANDBY** mode.

Flushing The Machine

When the machine has reached **STANDBY** mode, run the following 3 steps:

1. Press **2 Cup** button to run water through group head.
2. Run **Hot Water** for 30 seconds.
3. Activate **Steam** for 10 seconds.

TIP

You can manoeuvre your machine about the bench using the drop down swivel foot located under the drip tray.

START UP

Press the **POWER** button to switch the machine **ON**. The **POWER** button will flash and the **LCD** screen will display the current espresso boiler temperature.

When the machine has reached operating temperature, the **POWER** button light will stop flashing and the **MANUAL**, **1 CUP** and **2 CUP** buttons will illuminate.

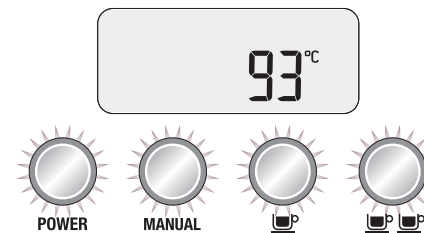

The machine is now in **STANDBY** mode ready for use.

NOTE

You will not be able to select **1 CUP**, **2 CUP** or **CLEANING CYCLE** during **START UP**.

AUTO OFF

The machine will turn off completely if not used for a continuous 20 minutes period.

LCD INTERFACE

Display modes

3 modes can be displayed on the **LCD** screen: *Shot Temp*, *Shot Clock* or *Clock*. Press **UP** or **DOWN** arrow to change the display mode between shot clock & clock. Shot clock will be displayed during an extraction. Shot temp will be displayed in **STANDBY** mode.

1. Shot Temp

Displays selected extraction temperature (default set at 93°C), but can be changed from 86°C - 96°C. See 'Extraction Temperature', page 15.

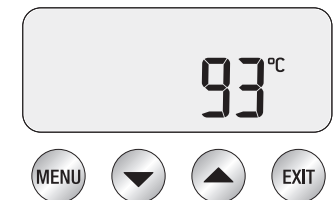

2. Shot Clock

Temporarily displays duration of last espresso extraction in seconds.

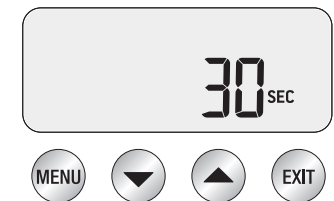

3. Clock

Temporarily displays current time (default set at 12.00am if time has not been set).



GENERAL OPERATION

1 CUP

Press 1 CUP once to extract a single shot of espresso at the pre-programmed duration (30secs). The extraction will start using the low pressure pre-infusion.

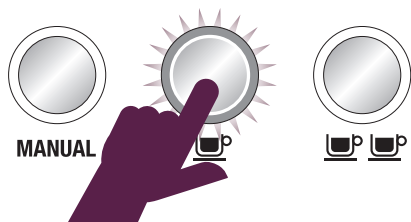

The machine will stop after 1 CUP volume has been extracted and will return to STANDBY mode.

2 CUP

Press 2 CUP button once to extract a double shot of espresso at the pre-programmed duration (30secs). The extraction will start using the low pressure pre-infusion.

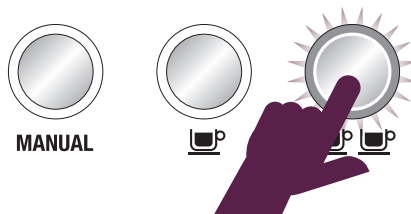

The machine will stop after 2 CUP volume has been extracted and will return to STANDBY mode.

MANUAL

The MANUAL button allows you to control the espresso pour volume to suit your preference.

Press MANUAL button once to start the espresso extraction. The extraction will start using the low pressure pre-infusion.

Press MANUAL button again to stop extraction.

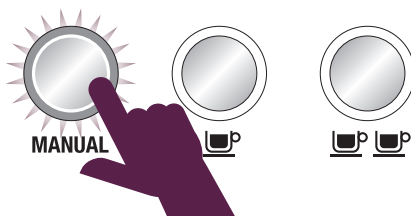

NOTE

To stop an extraction at any time, press the 1 CUP, 2 CUP or MANUAL button and the machine will return to STANDBY mode.

STEAM

For instant steam, move STEAM LEVER to OPEN position. The Steam LED will be On.

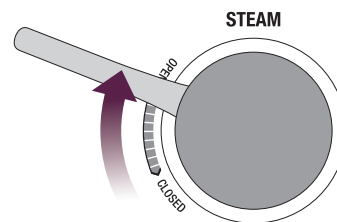

To turn STEAM off, move STEAM LEVER to CLOSED position. The machine will return to STANDBY mode.

CAUTION: BURN HAZARD

Pressurised steam can still be released, even after machine has been switched off.

Children must always be supervised.

HOT WATER

For instant hot water, rotate the HOT WATER dial to OPEN position. The Hot Water LED will be On.

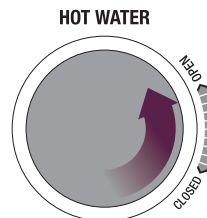

To turn HOT WATER off, rotate the HOT WATER dial to CLOSED position. The machine will return to STANDBY mode.

NOTE

You cannot run hot water and extract espresso at the same time.

LCD PROGRAMMING FUNCTIONS

To program the machine, press MENU button once. The LCD will display all programming functions. Continue to press MENU button to select your desired function.

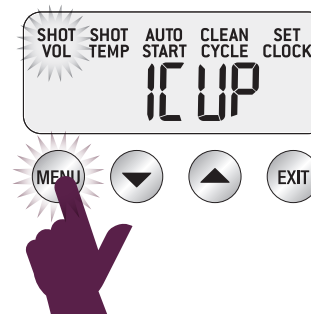

At any stage during programming, press EXIT to return to STANDBY mode.

NOTE

The MENU button is disabled when the machine is extracting espresso or delivering hot water.

SHOT DURATION

1 CUP Duration Programming

Press MENU button until SHOT VOL icon flashes and 1 CUP is displayed on the LCD screen.

Press 1 CUP button to start water flow from the group head.

Press 1 CUP again once required extraction duration has been reached.

The machine will beep twice to indicate the new 1 CUP duration has been set.

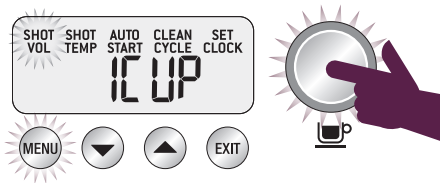

2 CUP Duration Programming

Press MENU button until SHOT VOL icon flashes and 2 CUP is displayed on the LCD screen.

Press 2 CUP button to start water flow from the group head.

Press 2 CUP again once required extraction duration has been reached.

The machine will beep twice to indicate the new 2 CUP duration has been set.

SHOT VOLUME

1 CUP Volume Programming

Press MENU button until SHOT VOL icon flashes and 1 CUP is displayed on the LCD screen.

Dose & tamp the portafilter with ground coffee. Press 1 CUP button to start espresso extraction. Press 1 CUP again once desired volume of espresso has been extracted.

The machine will beep twice to indicate the new 1 CUP volume has been set.

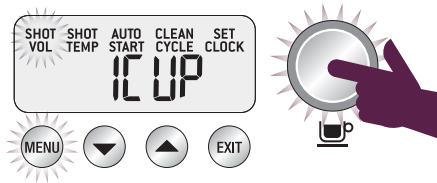

2 CUP Volume Programming

Press MENU button until SHOT VOL icon flashes and 2 CUP is displayed on the LCD screen.

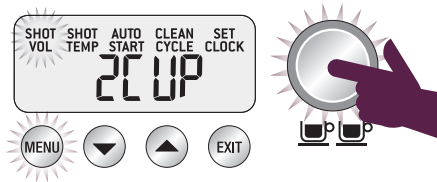

Dose & tamp the portafilter with ground coffee. Press 2 CUP button to start espresso extraction. Press 2 CUP again once desired volume of espresso has been extracted.

The machine will beep twice to indicate the new 2 CUP volume has been set.

NOTE

1 & 2 cup volumes use duration to control espresso volume as default setting. Access the Advanced Menu (page 17) if you wish to use Volumetric controls for these volumes.

EXTRACTION TEMPERATURE

Press MENU button until SHOT TEMP icon flashes. The LCD will display the current shot temperature setting.

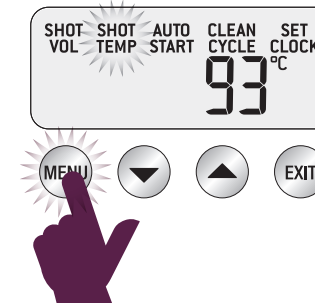

Press UP or DOWN arrow to adjust SHOT TEMP to the desired setting (range 86°C - 96°C).

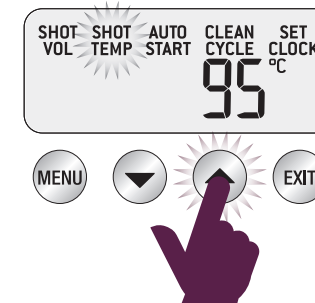

The new SHOT TEMP setting will be displayed on the LCD screen.

The optimum temperature will depend on the origin of the coffee beans, their freshness and degree of roast.

We recommend a temperature range of between 90°C-95°C for optimal flavour.

Press EXIT button. Machine will beep once to confirm setting.

AUTO START

To use AUTO START, first ensure clock has been set.

NOTE

Clock must first be set prior to activating the auto start feature. Refer to page 16.

Auto Start ON/OFF

Press MENU button until AUTO START icon flashes and the current Auto Start setting (ON or OFF) is displayed on the LCD screen.

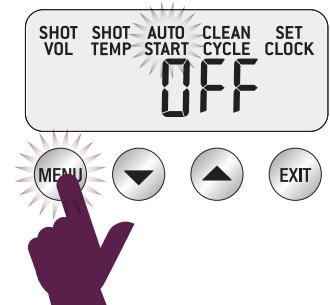

Press UP or DOWN arrow to set the AUTO START to ON or OFF.

If AUTO START is ON, the LCD will display a Clock icon.

Press MENU button and the current Auto Start time will be displayed on the LCD screen.

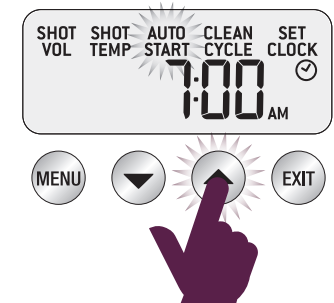

Press UP or DOWN arrow to adjust AUTO START to the desired time.
(default AUTO START time set at 7:00am).
Press EXIT button. Machine will beep once to confirm setting.

SET CLOCK

Press MENU button until SET CLOCK icon flashes. The current Clock Time will be displayed on the LCD screen.



Press UP or DOWN arrow to adjust the time.



Press EXIT button. Machine will beep once to confirm setting.

CLEAN CYCLE

Press MENU button until CLEAN CYCLE icon flashes and PUSH is displayed on the LCD screen.

To start the CLEAN CYCLE press the illuminated MANUAL button.

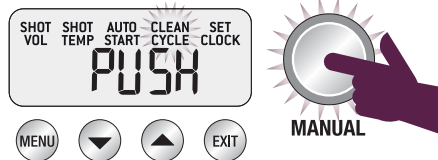

The CLEAN CYCLE icon will flash and the machine will start to countdown from 370 seconds.

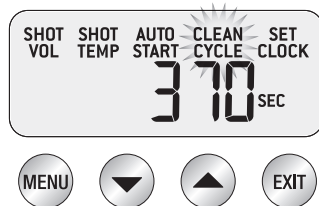

The machine will return to STANDBY when the cleaning cycle has ended.

Refer to cleaning instructions on page 23 for instructions.

ADVANCED MENU

Press & Hold - 1 CUP

Press & hold 1 CUP to bypass the pre-infusion phase and deliver water to the group head at the full 9 bar pressure. Release button to stop extraction. This function can be used when purging the group head.

Press & Hold - 2 CUP

Press & hold 2 CUP to bypass the pre-infusion phase and deliver water to the group head at the full 9 bar pressure. Release button to stop extraction. This function can be used when purging the group head.

Press & Hold - MANUAL

Press & hold the MANUAL button to deliver water to the group head at low pre-infusion pressure. When MANUAL button is released, water will continue at the full 9 Bars of pressure. Press MANUAL button again to stop extraction.

This function can be used to manually control the pre-infusion duration.

ACCESS ADVANCED MENU

To access the Advanced Menu:

With machine OFF, press and hold the 1 CUP button, then press the POWER button at the same time.

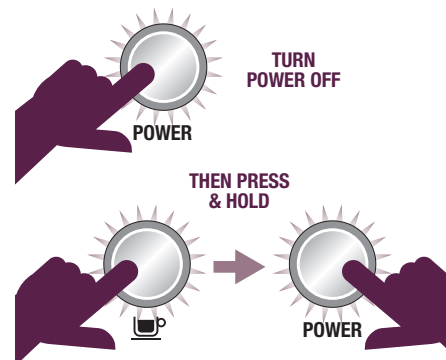

Resetting default settings

The machine has the following default settings:

1. Temperature - 93°C
2. Pre-Infusion - Duration Pr07
3. Pre-Infusion - Power PP60
4. Steam temperature - 135°C
5. Auto Start - OFF
6. Audio - LO
7. Water Hardness - 3
8. Espresso Volume durations - 30/30 secs

To reset machine to original default settings, first enter Advanced Menu. rSet will be displayed on the LCD. Press the MENU button to reset the machine to the default settings. The machine will beep 3 times to confirm.



The machine will then prompt you to set the water hardness. Select your water hardness using the UP & DOWN arrows & press MENU to confirm or press EXIT to return to STANDBY mode.



Temperature Unit - °C/°F (SEt)



Temperature Unit will be displayed on the LCD screen as SEt. Press MENU to Select. Use UP and DOWN arrows to select desired temperature unit. Press MENU to set. Machine will beep once to confirm selection. Press EXIT to return to STANDBY mode.

Steam Temperature (StEA)

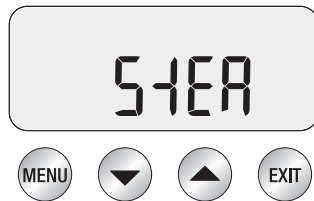

Adjust Steam Temperature to control the pressure of the steam being delivered. Lower steam temperature to texture smaller volumes of milk or have more control. Raise steam temperature to texture larger volumes of milk.

Press MENU to Select STEAM.

Use UP and DOWN arrows to select required steam temperature.

Press MENU to set.

Machine will beep once to confirm selection.

Machine Audio (Snd)

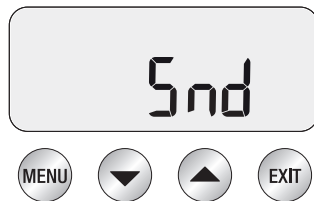

Machine Audio refers to the volume level of the 'beeps' heard.

- HI - high volume
- LO - low volume
- OFF - volume off

Press the MENU button to select Audio.

Press UP or DOWN arrows to select desired volume. Press MENU to set.

Machine will beep once to confirm selection.

Volumetric Control (vOL)



Use this function to set Duration or Volume to control the espresso output.

Press the MENU button to select. Use the UP or DOWN arrows to select FLo or Sec. Press MENU to set. Machine will beep once to confirm selection.

ADJUSTING PRE-INFUSION

Pre-Infusion Programming

With machine in STANDBY mode, press UP and DOWN arrows together to enter Pre-Infusion programming mode.

Press MENU button to move between Pre-infusion Duration and Power.

Pre-Infusion Duration

The LCD will display the current Pre-Infusion Duration.

Press UP or DOWN arrow to vary time.

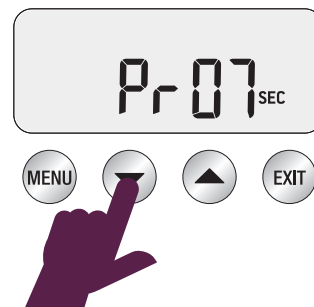

We recommend a range of between 5 - 15secs as being optimum.

Pre-Infusion Power

The LCD will display current Pre-Infusion Power.

Press UP or DOWN arrows to vary power.

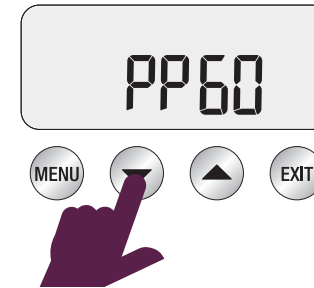

We recommend a range of between 55-65 as being optimum. Press EXIT to confirm setting and return to STANDBY mode.

ALERTS

STEAM LED Flashing At START UP

The machine will not enter START UP mode when the STEAM LEVER is in the OPEN position and the STEAM LED is flashing.

Move the STEAM LEVER to the CLOSED position for the machine to enter START UP mode.

HOT WATER LED Flashing At START UP

The machine will not enter START UP mode when the HOT WATER dial is in the OPEN position and the HOT WATER LED is flashing.

Move the HOT WATER dial to the CLOSED position for the machine to enter START UP mode.

HOT WATER LED Flashing

The HOT WATER LED will flash when the HOT WATER function has been operating for longer than 1 minute.

Move the HOT WATER dial to CLOSED position for machine to enter STANDBY mode.

FILL TANK

The machine will detect a low water level. The FILL TANK icon will be displayed on the LCD screen.

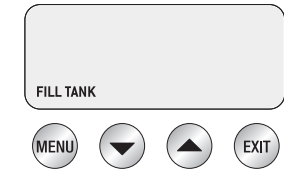

If FILL TANK icon is displayed, add water to tank until machine returns to STANDBY mode.

CLEAN ME!

The machine will detect when 200 extractions have been carried out since the last clean cycle.

The CLEAN ME! icon will be displayed on the LCD screen the next time the machine enters START UP mode.

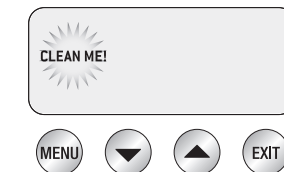

For information on how to clean the machine, refer to the CLEAN CYCLE instructions on page 23.

PRE-HEATING

Heating your cup or glass

A warm cup will help maintain the coffee's optimal temperature. Pre-heat your cup by rinsing with hot water from the Hot Water outlet and place on the cup warming tray.

Heating the portafilter and filter basket

A cold portafilter and filter basket can reduce the extraction temperature enough to significantly affect the quality of your espresso. Always ensure the portafilter and filter basket are pre-heated with hot water from the Hot Water outlet before initial use.

NOTE

Always wipe the filter basket dry before dosing with ground coffee as moisture can encourage channelling where water bypasses the ground coffee during extraction.

SELECTING FILTER BASKET

SINGLE WALL Filter Baskets

Use Single Wall filter baskets when grinding fresh whole coffee beans.

Single Wall filter baskets allow you to experiment with grind, dose and tamp to create a more balanced espresso.

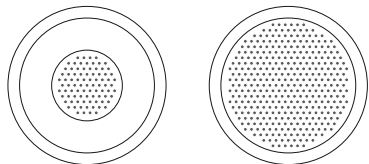

- Use the 1 cup filter basket when brewing single cups and the 2 cup filter basket when brewing two cups, stronger single cups or mugs.

DUAL WALL Filter Baskets

Use Dual Wall filter baskets if using pre-ground coffee.

Dual Wall filter baskets regulate the pressure and help to optimise the extraction regardless of the grind, dose, tamp pressure or freshness.

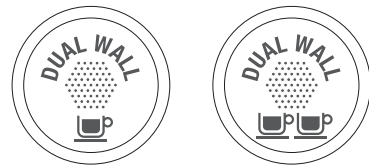

- Use the 1 cup filter basket when brewing single cups and the 2 cup filter basket when brewing two cups, stronger single cups or mugs.

THE GRIND

When grinding coffee beans, the grind size should be fine but not too fine. The grind size will affect the rate at which the water flows through the ground coffee in the filter basket and the taste of the espresso.

If the grind is too fine (looks like powder and feels like flour when rubbed between fingers), the water will not flow through the coffee even when under pressure. The resulting espresso will be **OVER EXTRACTED**, dark in colour and bitter in flavour.

If the grind is too coarse the water will flow through the ground coffee in the filter basket too quickly. The resulting espresso will be **UNDER EXTRACTED** lacking in colour and flavour.

COFFEE DOSE AND TAMPING

- Wipe coffee basket with a dry cloth.
- Using Single Wall filter baskets, grind enough coffee to fill the coffee basket.

- Tap the portafilter several times to collapse and distribute the coffee evenly in the filter basket.
- Tamp down firmly (using approx. 15 - 20kgs of pressure). The amount of pressure is not as important as consistent pressure every time.

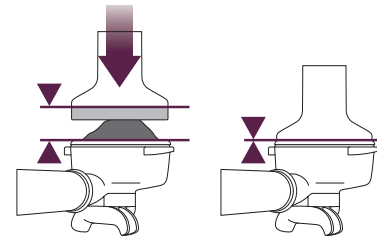

- As a guide to dose, the top edge of the metal cap on the tamper should be level with the top of the filter basket **AFTER** the coffee has been tamped.

TRIMMING THE DOSE

- Insert the Razor™ dosing tool into the coffee basket until the shoulders of the tool rest on the rim of the basket. The blade of the dosing tool should penetrate the surface of the tamped coffee.
- Rotate the Razor™ dosing tool back and forth while holding the portafilter on an angle over the knock box to trim off excess coffee grinds. Your coffee filter basket is now dosed with the correct amount of coffee.

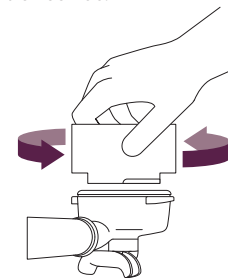

- Wipe excess coffee from the rim of the filter basket to ensure a proper seal is achieved in the group head.

NOTE

If the extraction is too fast, make the grind finer & repeat above steps.
If the extraction is too slow, make the grind coarser and repeat above steps.

PURGING THE GROUP HEAD

- Before placing the portafilter into the group head, run a short flow of water through the group head by pressing and holding the 1 CUP button. This will purge any ground coffee residue from the group head and stabilise the temperature prior to extraction.

INSERTING THE PORTAFILTER

Place the portafilter underneath the group head so that the handle is aligned with the INSERT position. Insert the portafilter into the group head and rotate the handle towards the centre until resistance is felt.

EXTRACTING ESPRESSO

- Place pre-warmed cup(s) beneath the portafilter and press the 1 CUP or 2 CUP button for the required volume.
- As a guide, the espresso will start to flow after 8-10 seconds (infusion time) and should be the consistency of dripping honey.
- If the espresso starts to flow after less than 6 seconds you have either under dosed the filter basket and/or the grind is too coarse. This is an **UNDER EXTRACTED** shot.
- If the espresso starts to drip but doesn't flow after 15 seconds, the grind is too fine. This is an **OVER EXTRACTED** shot.

A great espresso is about achieving the perfect balance between sweetness, acidity and bitterness.

COFFEE MAKING TIPS & PREPARATION

The flavour of your coffee will depend on many factors, such as the type of coffee beans, degree of roast, freshness, coarseness or fineness of the grind, dose of ground coffee and tamping pressure.

Experiment by adjusting these factors just one at a time to achieve the taste of your preference.

EXTRACTION GUIDE

	GRIND	SHOT TIME
OVER EXTRACTED BITTER • ASTRINGENT	TOO FINE	OVER 40 SEC
BALANCED	OPTIMUM	25-35 SEC
UNDER EXTRACTED UNDERDEVELOPED • SOUR	TOO COARSE	UNDER 20 SEC

TEXTURING MILK

- Always start with fresh cold milk.
- Fill the jug just below the “V” at the bottom of the spout.
- Position the steam tip above the drip tray and lift the steam lever to purge the steam wand of any condensed water.
- Insert the steam tip 1-2cm below the surface of the milk close to the right hand side of the jug at the 3 o'clock position.
- Lift the steam lever.
- Keep the tip just under the surface of the milk until the milk is spinning clockwise, producing a vortex (whirlpool effect).
- With the milk spinning, slowly lower the jug. This will bring the steam tip to the surface of the milk & start to introduce air into the milk. You may have to gently break the surface of the milk with the tip to get the milk spinning fast enough.

- Keep the tip at or slightly below the surface, continuing to maintain the vortex. Texture the milk until sufficient volume is obtained.
- Lift the handle of the jug to lower the tip beneath the surface, but keep the vortex of milk spinning. The milk is at the correct temperature (60-65°C) when the jug is hot to touch.
- Move the steam lever to the CLOSED position BEFORE taking the tip out of the milk.
- Set the jug to one side, lift the steam lever to purge out any residual milk from the steam wand and wipe steam wand with a damp cloth.
- Tap the jug on the bench to collapse any bubbles.
- Swirl the jug to “polish” and re-integrate the texture.
- Pour milk directly into the espresso.
- The key is to work quickly, before the milk begins to separate and the crema dissipates.

HINTS & TIPS

- Always use freshly ground coffee for a superior flavour and body.
- Use freshly roasted coffee beans, with a roasted-on date and use within 3 weeks of roasted-on date.
- Store coffee beans in a cool, dark and dry container. Vacuum seal if possible.
- Buy coffee beans in small batches to reduce the storage time and store no more than one week's supply at any time.
- Grind beans immediately before brewing as ground coffee quickly loses its flavour and aroma.

CARE & CLEANING

CLEANING CYCLE

- CLEAN ME! will be displayed on the LCD to indicate when a cleaning cycle is required (approx. 200 shots).
- Insert the supplied cleaning disc, followed by 1 cleaning tablet into the 1 CUP filter basket.
- Insert the portafilter and lock into group head.
- Ensure the water tank is filled with cold tap water.
- Ensure the drip tray is empty & inserted.
- Press MENU button until CLEAN CYCLE icon flashes and PUSH is displayed on the LCD screen.

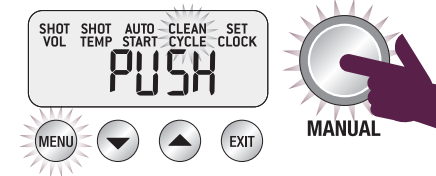

- To start the Clean Cycle press the illuminated MANUAL button.
- The CLEAN CYCLE icon will flash and the machine will start to countdown from 370 seconds.
- When the cleaning cycle has finished, remove the portafilter and ensure the tablet has completely dissolved. If the tablet has not dissolved, repeat the steps above, without inserting a new tablet.
- Rinse the filter basket and portafilter thoroughly before use.

INSTALLING WATER FILTERS

- Soak filter in a glass of water for 5 minutes.
- Rinse the filter and mesh under running water.
- Assemble filter into filter holder.
- Set replacement date forward 2 months.
- Install filter holder into water tank.
- Insert water tank into the machine. Ensure the latch is locked into position.

NOTE

To purchase filters contact Breville Customer Service Centre on AUS 1300 139 798 NZ 0800 273 845 or visit www.breville.com.au

NOTE

Change filters every 2 months. Contact Breville Customer Service Centre for advice.

CLEANING THE STEAM WAND

- Wipe the steam wand with a damp cloth & purge directly after texturing the milk.
- If any of the holes in the tip of the steam wand become blocked, ensure the STEAM LEVER is in the CLOSED position and clean using the pin on the end of the cleaning tool.
- If steam wand remains blocked, remove the tip using the integrated spanner in the cleaning tool and soak in hot water. Screw tip back onto the steam wand using the integrated spanner in the cleaning tool.

CARE & CLEANING

CLEANING THE FILTER BASKETS AND PORTAFILTER

- The filter baskets and portafilter should be rinsed under hot water directly after use to remove all residual coffee oils. If the holes in the filter baskets become blocked, dissolve a cleaning tablet in hot water and soak filter basket and portafilter in solution for approx. 20 minutes. Rinse thoroughly.

CLEANING THE SHOWER SCREEN

- The group head interior and shower screen should be wiped with a damp cloth to remove any ground coffee particles.
- Periodically run hot water through the machine with the filter basket and portafilter in place, without ground coffee, to rinse out any residual coffee.

CLEAR WATER BACK-FLUSH

- Insert the cleaning disc into the 1 cup filter basket.
- Insert portafilter into the group head.
- Press the 1 CUP button to build pressure in the basket.
- Repeat several times to remove residual coffee oils in the espresso water paths.

CLEANING THE DRIP & STORAGE TRAY

- The drip tray should be removed, emptied and cleaned after each use or when the drip tray indicator is showing Empty Me!
- Remove grill from the drip tray. Wash the drip tray in warm soapy water. The Empty Me! indicator can also be removed from the drip tray.
- The storage tray can be removed and cleaned with a soft, damp cloth (do not use abrasive cleaners, pads or cloths which can scratch the surface).

CLEANING THE OUTER HOUSING & CUP WARMING TRAY

- The outer housing and cup warming tray can be cleaned with a soft, damp cloth. Polish with a soft, dry cloth. Do not use abrasive cleaners, pads or cloths which can scratch the surface.

NOTE

Do not clean any of the parts or accessories in the dishwasher.

DESCALE (dESC)

Use this function to access descale procedures when a descale alert is displayed on the LCD.

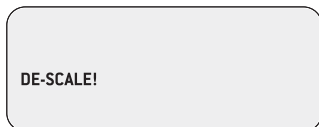

Please ensure you allow approximately 1.5 hour to complete the entire descale process and follow the step by step instructions.

If you've just finished using your machine, please ensure to turn the machine off and allow to cool for at least 1 hour before starting your descale process.

1 – Prepare for Descale

- Empty the drip tray and insert into position.
- Turn the machine off and allow to cool for at least 1 hour. With the machine off, press and hold the 1 CUP button, then press and hold the POWER button together for 3 seconds. rSEt will appear on the LCD.

CARE & CLEANING

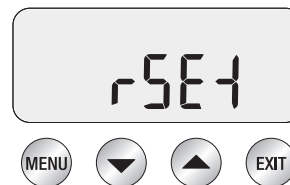

- Press UP or DOWN arrow to set mode, the 'dESC' will appear on the LCD. Press the MENU button to enter Descale mode.

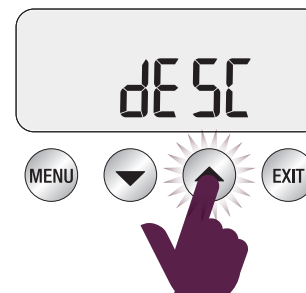

2 – Empty Boilers

- Remove the grey silicone cover on the lower front panel marked DESCAL ACCESS. Place a cloth over the drip tray to stop steam escaping.

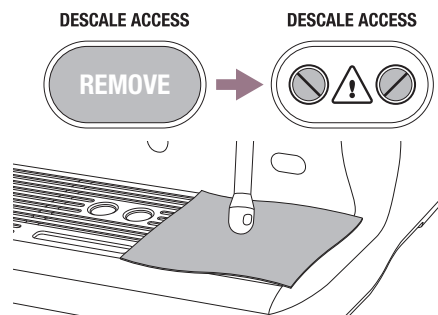

- Use a flat-head screwdriver to rotate the right screw counter-clockwise until the valve is fully open. As the valve opens, steam may be released.

NOTE

If there's no water released into the drip tray, press and hold the 1 CUP button for 3 seconds. This will release water from the boiler

When the water is completely empty, close the valve by rotating screws clock-wise until seated. Do not overtighten screws to avoid damages to the valves.

DESCAL ACCESS

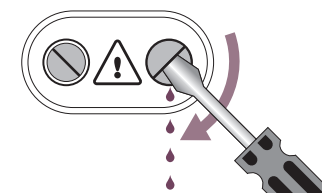

- Next, repeat the above process on the left screw.
- Empty the drip tray. Use caution as the drip tray may be hot.
- Empty water tank, remove water filter.
- Place descale solution into water tank, fill with cold water to MAX line, (if an alternative cleaning solution is used, please follow the manufacturer's instructions accordingly). Lock water tank back into position at the back of the machine.

CARE & CLEANING

3 – Begin Descale

Press 1 CUP button to proceed.

Machine will fill boilers with descale solution and heat to temperature. During this time, water may flow through the group head. Wait for countdown timer to reach 0. This allows solution to dissolve scale build-up. However you can proceed to the next step at any time by pressing the 1 Cup button.



- Place a cloth over the drip tray to stop steam escaping.
- Empty boilers by repeating steps 2b and 2C.
- Empty drip tray and insert back to place.
- Empty water tank then rinse and fill with clean water to the MAX line. Lock water tank back into position.

4 – Flush Boilers

Press 1 CUP button to proceed.

During this procedure, the LCD will show countdown time (20 minutes).



During this time, the machine will fill boilers with fresh clean water and heat to temperature. You can proceed to the next step at any time by pressing the 1 Cup button.

- Place a cloth over the drip tray to stop steam escaping.
- Empty boilers by repeating steps 2b and 2C.
- Empty drip tray and insert back to place.
- Empty water tank then rinse and fill with clean water to the MAX line. Lock water tank back into position.

5 - Repeat Step 4 Flush Boilers

We recommend flushing boilers again to ensure any residual descale solution is released from the boilers.

Press POWER button to exit the Descale mode. The descale process is now complete and ready to use.

TROUBLESHOOTING

PROBLEM	POSSIBLE CAUSES	WHAT TO DO
The Hot Water LED flashes when the machine is turned On	<ul style="list-style-type: none"> Hot Water dial is open. 	Turn the Hot Water dial to the CLOSED position.
The Steam LED flashes when the machine is turned On	<ul style="list-style-type: none"> Steam Lever is open. 	Move the Steam Lever to the CLOSED position.
Water does not flow from the group head	<ul style="list-style-type: none"> Machine has not reached operating temperature. 	Allow time for the machine to reach operating temperature. The POWER light will stop flashing when machine is ready.
	<ul style="list-style-type: none"> Water tank is empty. 	Fill Tank.
	<ul style="list-style-type: none"> Water tank not fully inserted & locked. 	Push water tank in fully and close the latch.
FILL TANK displayed on LCD, but water tank is full	<ul style="list-style-type: none"> Water tank is not fully inserted and locked into position. 	Push water tank in fully and close the latch.
No Steam or Hot Water	<ul style="list-style-type: none"> Machine is not turned on. 	Ensure the machine is plugged in, switched On at the power outlet and the POWER button is On.
No Hot Water	<ul style="list-style-type: none"> Water tank is empty. 	Fill water tank.
No Steam	<ul style="list-style-type: none"> Steam Wand is blocked. 	Use the pin on the cleaning tool to clear the holes. If the steam wand continues to be blocked remove the tip of the steam wand using the spanner in the cleaning tool and soak in hot water.

TROUBLESHOOTING

PROBLEM	POSSIBLE CAUSES	WHAT TO DO
The machine is 'On' but ceases to operate		Turn machine Off. Wait for 60 minutes and turn machine back On. If problem persists, call Breville Customer Service AUS 1300 139 798 and NZ 0800 273 845.
Steam pouring out of group head		Turn machine Off. Wait for 60 minutes and turn machine back On. If problem persists, call Breville Customer Service AUS 1300 139 798 and NZ 0800 273 845.
Espresso just drips from the portafilter spouts	• Coffee is ground too finely.	Use slightly coarser grind.
	• Too much coffee in the filter basket.	Lower dose of coffee using the RAZOR™ dosing tool.
	• The filter basket may be blocked.	Use the fine pin on the provided cleaning tool to clear the outlet hole(s) on the underside of the filter basket. If it continues to be blocked, dissolve a cleaning tablet in hot water and soak filter basket and portafilter in the solution for approx. 20 minutes. Rinse thoroughly.

TROUBLESHOOTING

PROBLEM	POSSIBLE CAUSES	WHAT TO DO
Espresso runs out too quickly and/or Pressure gauge not reaching 9 bar	• The coffee is ground too coarse.	Use slightly finer grind.
	• Not enough coffee in the filter basket.	Increase dose of coffee and use the RAZOR™ dosing tool to trim off excess coffee after tamping.
Pressure gauge not reaching 9 bar	• Coffee not tamped firmly enough.	Tamp between 15-20kgs of pressure.
		If the above suggestions do not help, check the machine. Place an EMPTY Dual Wall filter basket into the portafilter (either 1 CUP or 2 CUP). Press the MANUAL button. If the pressure gauge reads over 5 bar the machine is OK. Ensure correct dose by using the RAZOR™ dosing tool. If the dose is correct, make the grind finer. If the pressure gauge reads below 5 bar, contact Breville Customer Service Centre AUS 1300 139 798 NZ 0800 273 845.
Coffee not hot enough	• Cups not preheated.	Rinse cups under hot water outlet and place on cup warming tray.
	• Milk not hot enough (if making a cappuccino or latte etc).	Heat milk until base of the jug becomes hot to touch.

TROUBLESHOOTING

PROBLEM	POSSIBLE CAUSES	WHAT TO DO
No crema	<ul style="list-style-type: none"> Coffee beans are stale. 	Buy freshly roasted coffee with a roasted-on date.
	<ul style="list-style-type: none"> Using Single Wall Filter Baskets with pre-ground coffee. 	Ensure you use Dual Wall Filter Baskets with pre-ground coffee.
Espresso runs out around the edge of the portafilter and/or Portafilter comes out of the group head during an extraction	<ul style="list-style-type: none"> Portafilter not inserted in the group head correctly. 	Ensure portafilter is rotated to the right until the handle is past the centre and is securely locked in place. Rotating past the center will not damage the silicone seal.
	<ul style="list-style-type: none"> There are coffee grounds around the filter basket rim. 	Clean excess coffee from the rim of the filter basket to ensure a proper seal in group head.
	<ul style="list-style-type: none"> Filter basket rim is wet or underside of portafilter lugs are wet. Wet surfaces reduce the friction required to hold the portafilter in place whilst under pressure during an extraction. 	Always ensure filter basket and portafilter are dried thoroughly before filling with coffee, tamping and inserting into the group head.
	<ul style="list-style-type: none"> Too much coffee in the filter basket. 	Trim coffee dose using the RAZOR™ dosing tool after tamping.
Unable to set auto start time	<ul style="list-style-type: none"> Clock not set. 	Set clock.
E1, E2 or E3 error message on LCD screen	<ul style="list-style-type: none"> An error that cannot be reset by the user has occurred. 	Contact Breville Customer Service Centre AUS 1300 139 798 NZ 0800 273 845.

TROUBLESHOOTING

PROBLEM	POSSIBLE CAUSES	WHAT TO DO
Coffee puck is sticking to the shower screen	<ul style="list-style-type: none"> This is normal and happens occasionally. The dry puck feature creates a slight vacuum on top of the coffee puck which will occasionally hold the puck against the shower screen instead of leaving it in the filter basket. 	
Pumps continue to operate / Steam is very wet / Hot water outlet leaks	<ul style="list-style-type: none"> Using de-mineralised or distilled water which is affecting how the machine is designed to function. 	We recommend using cold, filtered water. We do not recommend using water with no/low mineral content such as de-mineralised or distilled water. If the problem persists, contact Breville Customer Service Centre AUS 1300 139 798 NZ 0800 273 845.

**CAPPUCCINO**

A single shot of espresso with textured milk and garnished with drinking chocolate.

**ESPRESSO**

A single shot of espresso. Intense and aromatic, it is also known as a short black and is served in a small cup or glass.

**LATTÉ**

A latte consists of a single espresso with textured milk and approx. 10mm of foam.

**MACCHIATO**

Traditionally served short, the macchiato can also be poured as a long black with a dash of milk or a dollop of textured milk.

**LONG BLACK**

Add hot water first, then a shot of espresso (single or double) so that crema is maintained.

**RISTRETTO**

A ristretto is an extremely short espresso of approximately 15ml, distinguished by its intense flavour and aftertaste.