

# Operation & Maintenance Manual

**MONTIGO®**

## Proflame 2 System

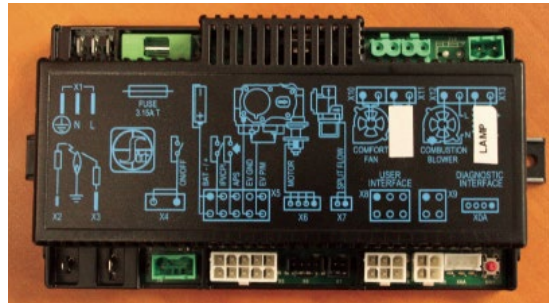

### NOTICE

Read these instructions before use.

### WARNING

Do not operate in presence of water dripping, spraying, rain, etc.

### CAUTION

**Property Damage Hazard. Excessive heat can cause property damage.**  
The appliance can stay lit for many hours. Turn off the appliance if it is not going be attended for any length of time.

### WARNING

When installing the fireplace - gas lines, fittings, accessories or any other objects cannot impede the proper movement of the door buckles.

### ATTENTION

- Turn OFF the main gas supply of the appliance during installation or maintenance of the receiver device.
- Turn OFF main gas supply to the appliance prior to removing or reinserting the batteries.
- In case of remote control malfunction turn OFF the IFC device using the On/Off main switch.
- For installation / maintenance switch OFF the IFC device by removing main power supply plug and disconnect.

### WARNING

**FIRE HAZARD. Can cause severe injury or death.** The Transmitter and IFC device causes ignition of the appliance. The appliance can turn on suddenly. Keep away from the appliance burner when operating the remote system or activating manual bypass of the remote system.

### WARNING

Some materials used in the manufacturing process of this product can expose you to Benzene which is known in the State of California to cause cancer and birth defects or other reproductive harm. For more information go to [www.P65warnings.ca.gov](http://www.P65warnings.ca.gov)





## Operation

### The Proflame 2 System consists of the following elements:

1. Pilot Assembly
2. Proflame Gas Valve.
3. Proflame 2 Control Module
4. Wiring Harness
5. Variable Speed comfort fan \*
6. Accent Lights \*
7. Proflame 2 remote control
8. Battery Pack (not applicable for power vented units)
- 9 Manual override switch

\* Not available on all fireplace models. Refer to the fireplace instruction guide for available features.

### The Proflame 2 Transmitter controls the following fireplace functions:

1. Main Burner On/Off
2. Main Burner flame modulation (6 levels).
3. Choice of standing or intermittent pilot (CPI/IPI).
4. Thermostat and Smart thermostat functions.
5. Accent light On/Off.
6. Comfort fan speed modulation (6 levels).

The Proflame 2 Transmitter uses a streamline design with a simple button layout and informative LCD display, see **figure 1**. A Mode Key is provided to index between the features and a Thermostat Key is used to turn On/Off or index through Thermostat functions, see **figure 1 & 3**. Additionally, a Key Lock feature is provided, see **figure 15**.



### IMPORTANT

The Proflame Transmitter 2 is an integrated part of the Proflame 2 System, which consists of these elements:

- Proflame 2 Transmitter, to be used in conjunction with:
- Integrated Fireplaces Control (Proflame 2 IFC)



### WARNING

Do not expose remote control to temperatures below 0°C (32°F) or above 50°C (122°F)

# Operation



**Figure 1.** Proflame Remote Control

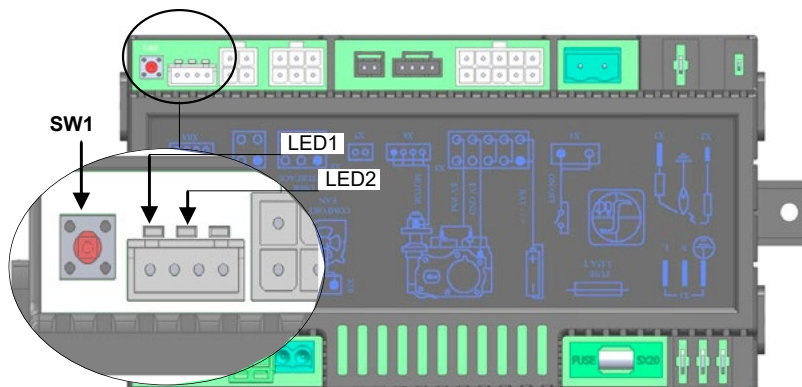

**SW1 = Programing Button**

**LED1 = Red Diagnostic Light**

**LED2 = Amber Programing Remote Control Light**

**Figure 2.** Proflame Control Module



# Operation

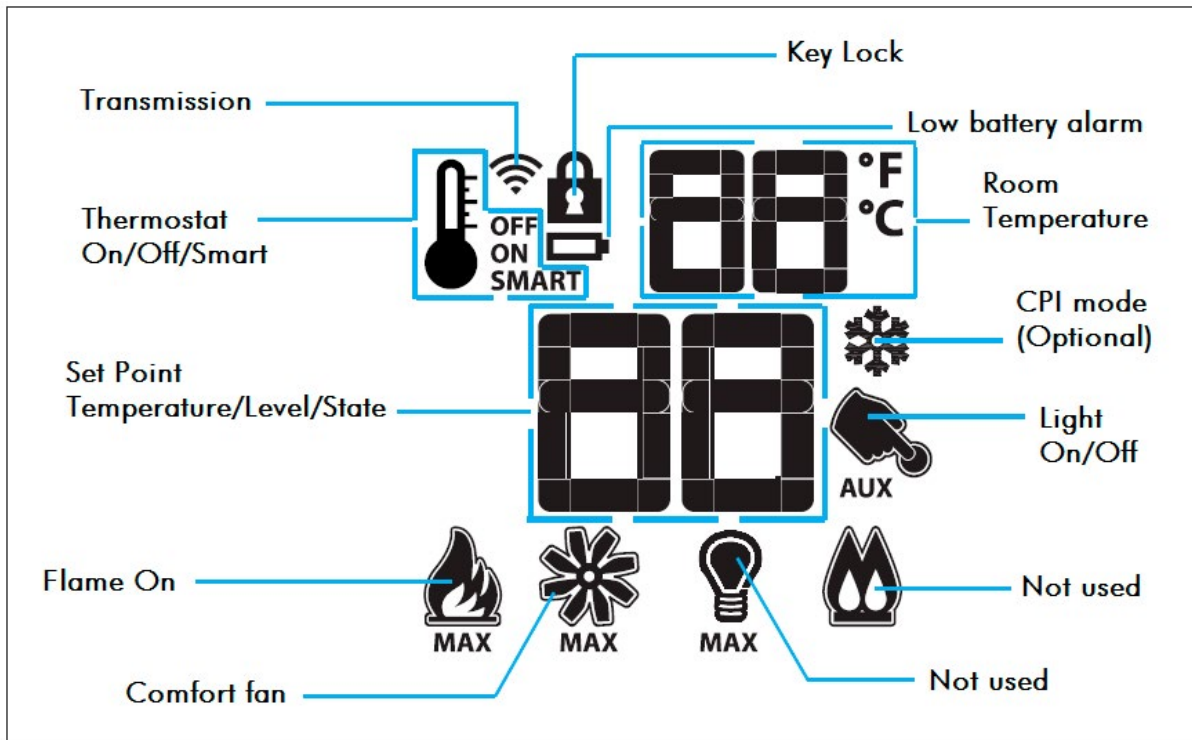

Figure 3. Remote Control LCD display.

## Initializing the System for the first time

1. Install four (4) AA batteries into the battery holder located under the firebox. (Not applicable for Power Vented Units)
  2. Install three (3) AAA batteries in the back of the remote control, see **figure 4a**.
- Note the polarity of batteries and install them as indicated by the silk screen (+/-) on the holder.
3. Set manual switch to OFF position, see **figure 6**.
  4. Connect AC Power (120 volts, 60 Hz) to fireplace.

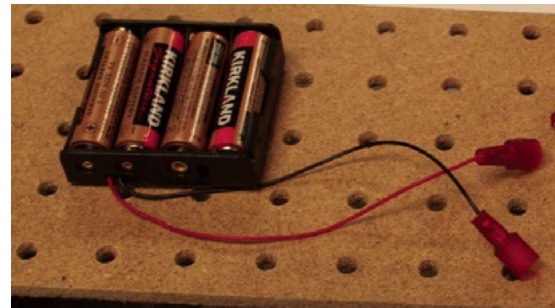

Figure 4. Control Module Battery Pack (Not applicable for Power Vented Units)

## Operating the System for the first time

5. Press SW1 button on the control module. The control module will beep three (3) times and amber LED, see **figure 2**, is illuminated to indicate that the IFC is ready to synchronize with a remote control within 10 sec. Push the ON button. The control module will "beep" four (4) times to indicate transmitter's command is accepted.

The System is now initialized.

**⚠ WARNING**

**Battery operated device.** Read the battery instructions before installing them into the system. Do not expose any battery, or its holder, or a device in which batteries are installed, to a working temperature greater than 54°C / 129°F. Avoid battery overheating even if the working temperature of the device to which the batteries are connected is reported to be greater than 54°C / 129°F. In case of overheating the bad cases, develop hydrogen gas and explode.



Figure 4a. Remote control battery compartment.

# Operation



## Temperature indication Display

With the system in the "Off" position, press the Thermostat Key and the Mode Key at the same time. Look at the LCD screen on the Remote Control to verify that a C or F is visible to the right of the Room Temperature display, see **figure 5** .

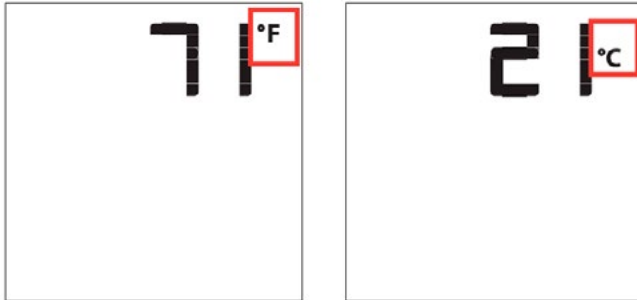

**Figure 5.** Remote Control display in Farenheit & Celsius.

## Turn On the Fireplace

With the system Off, turn the manual On/Off switch to on and press the On/Off Key on the Remote Control. The manual On/Off switch is located on the right side of the fireplace under the valve blind cover. The Remote Control display will show some other active Icons on the screen. At the same time the Control Module will activate the fireplace. A single "beep" from the Control Module will confirm reception of the command.



**Figure 6.** Manual On/Off Switch

## Turn Off the Fireplace

With the system On, press the On/Off Key on the Remote Control. The Remote Control LCD display will only show the room temperature, see **figure 7**. At the same time the Control Module will turn off the fireplace. A single "beep" from the Receiver confirms reception of the command.

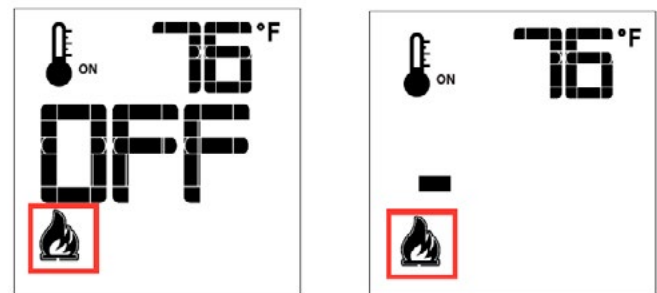

**Figure 7.** Remote Control display.

## Remote-Flame Control

The proflame has six (6) flame levels. With the system on, and the flame level at the maximum in the fireplace, pressing the Down Arrow Key once will reduce the flame height by one step until the flame is turned off.

The Up Arrow Key will increase the flame height each time it is pressed. If the Up Arrow Key is pressed while the system is on but the flame is off, the flame will come on in the high position, see **figure 8 & 9**.



**Figure 8.** Flame Off and Flame Level 1.

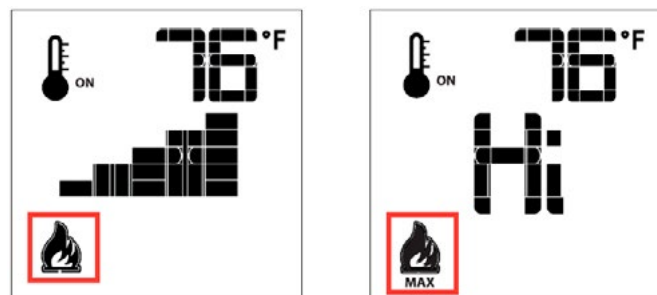

**Figure 9.** Flame Level 5 and Flame Level Maximum.





# Operation

## Room Thermostat (Remote Control Operation)

The Remote Control can operate as a room thermostat. The thermostat can be set to a desired temperature to control the comfort level in a room. To activate the function, press the Thermostat Key, see **figure 1**. The LCD display on the remote control will change to show that the room thermostat is "On" and the set temperature is now displayed, see **figure 10**. To adjust the set temperature press the Up or Down Arrow Keys until the desired set temperature is displayed on the LCD screen of the Transmitter.

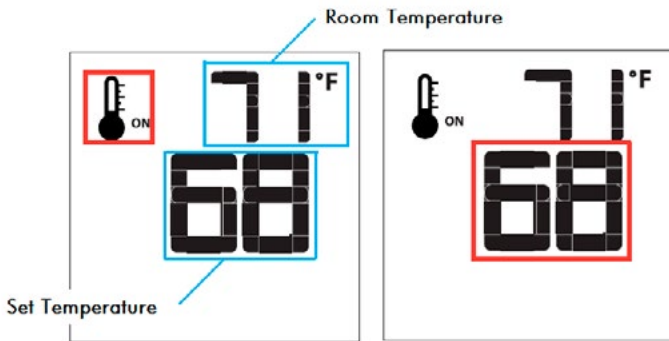

Figure 10. Setting Room Thermostat

## Smart Thermostat (Remote Control Operation)

The Smart Thermostat function adjusts the flame height in accordance to the difference between the set point temperature and the actual room temperatures. As the room temperature gets closer to the set point the Smart Function will modulate the flame down. To activate the function, press the Thermostat Key, see **figure 1**, until the word "SMART" appears to the right of the temperature bulb graphic, see **figure 11**.

**NOTE:** When smart Thermostat is activated, manual flame height adjustment is disabled.

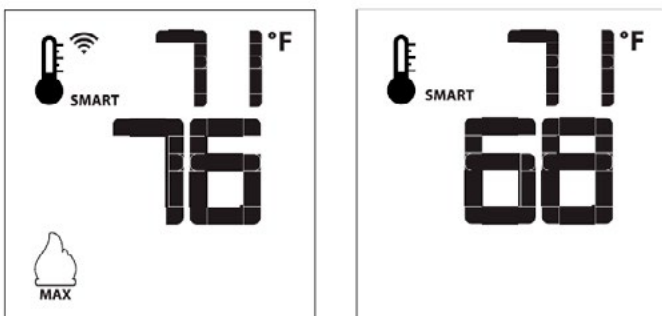

Figure 11. Smart flame function

## Fan Speed Control

The fireplace may be equipped with a hot air circulating fans. The speed of the fan can be controlled by the Proflame system. The fan speed can be adjusted through six (6) speeds. To activate this function use the Mode Key, see **figure 1**, to index to the fan control icon, see **figure 12**. Use the Up/Down Arrow Keys, see **figure 1**, to turn on, off, or adjust the fan speed, see **figure 12**. A single "beep" will confirm reception of the command.

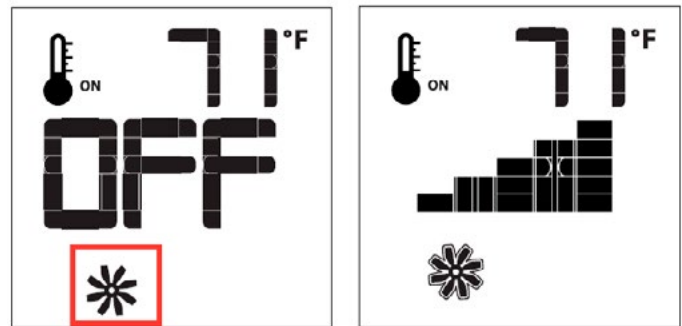

Figure 12. Fan Speed Control

## Accent Light Control

The fireplace may be equipped with accent lights. The auxiliary function controls the Accent Lights. To activate this function use the Mode Key, see **figure 1**, to index to the AUX icon, see **figure 13**.

Pressing the Up Arrow Key will turn the light on. Pressing the Down Arrow Key will turn the light off. A single "beep" will confirm the reception of the command.

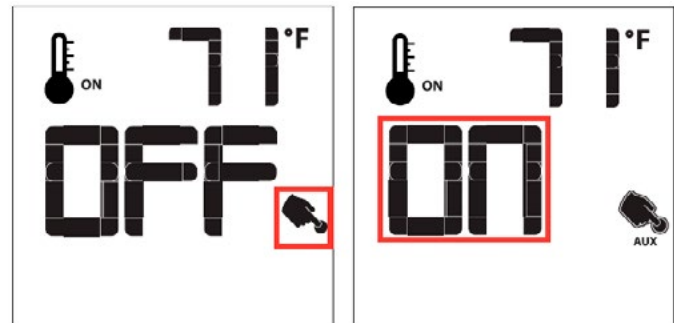

Figure 13. Light Control

# Operation



## Continuous Pilot (CPI) Selection (Optional)

In cold weather climates, the pilot burner can stay on continuously to prevent condensation or cold air temperatures near the fireplace glass. **Note**, some jurisdictions do not permit use of continuous pilot system. Check local codes or contact your Montigo dealer.

### WARNING:

**Do NOT use CPI with optional Power Vent.**

With the system in "off" position press the Mode Key, see **figure 1**, to index to the CPI mode icon, see **figure 14**. Pressing the Up Arrow Key will activate the Continuous Pilot Ignition mode (CPI). Pressing the Down Arrow Key will return to IPI. A single "beep" will confirm the reception of the command.

### NOTE:

- Requires CPI switch (not supplied).
- Set the CPI/IPI switch to CPI position (Switch closed) to enable remote CPI/IPI operation.
- Set the CPI/IPI switch to IPI position (switch open) to disable remote CPI/IPI operation. The system will now work in IPI mode only regardless of the selection on the remote control hand set.

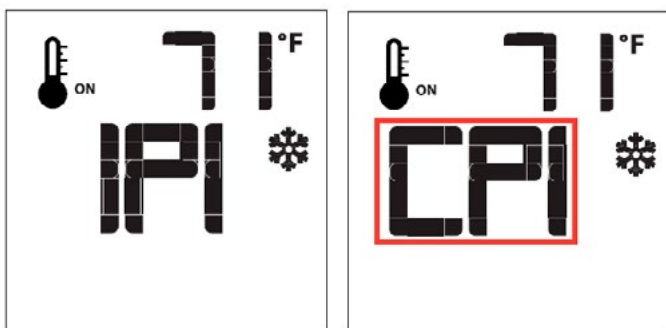

**Figure 14.** Continuous Pilot / Intermittent Pilot Selection

## Key Lock

This function will lock the keys to avoid unsupervised operation. To activate this function, press the Mode and Up Keys and the same time, see **figure 15**. To deactivate this function, press the Mode and Up Keys and the same time.

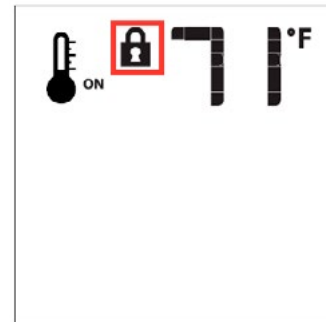

**Figure 15.** Key Lock



# Maintenance

## Low Battery Power Detection

The life span of the batteries depends on various factors: quality of the batteries used, the number of ignitions of the appliance, the number of changes to the room thermostat set point, etc.

### Remote Control

When the Remote Control batteries are low, a Battery Icon will appear on the LCD display of the Remote Control, see **figure 16**, before all battery power is lost. When the batteries are replaced this icon will disappear.



**Figure 16.** Low Battery Power Detection

### Control Module

(Not applicable for Power Vented Units)

When the Control Module batteries are low, a "double-beep" will be emitted from the IFC when it receives an On/Off command from the Remote Control. This is an alert for a low battery condition of the receiver and after that no more command will be accepted. When the batteries are replaced the "beep" will be emitted from the receiver as soon as powered.

### Troubleshooting:

Below is a list of possible problems and solutions.

Problem	Solution
Control module beeps twice when On/Off button on remote is pressed and Red LED is On.	Replace batteries in battery pack. (Not applicable for Power Vented Units)
Lights and Fans will not turn On.	Check main power is On.
Pilot will not spark.	Check and turn main On/Off switch to On.
Main burner will not light.	Check wiring



# Maintenance



## CPI [Continuous Pilot Ignition] / IPI [Intermittent Pilot Ignition] Jumper Cable Installation

### “Why use CPI mode”?

There are several reasons why you may choose to use CPI mode. When a flue is cold it can be difficult to light the appliance. It can take a bit of time (particularly on tall vents) to initialize vent action. This can result in “lifting” or “ghosting” of the flames during the first two to three minutes of operation. It is also possible to encounter times when the fireplace fails to light successfully. The fireplace will then attempt to re-light a second or third time depending on prevailing temperatures or altitude. When in CPI mode the pilot also keeps the system warm. During a “cold” start, condensation will normally form on the inner glass surface of the door. This condensation will quickly dry, however, the condensation tends to run down the glass and cause some streaking. CPI mode helps to resolve this issue. If CPI mode is used during the winter months the energy it takes to run the pilot is partially recovered as heat into the building, so it does not waste as much energy as running a pilot in the off season.

A connector is supplied with this unit that can be plugged into the controller. This Jumper Cable gives the Remote Control the ability to operate the CPI / IPI switch and set the unit to operate in either condition. CPI means “Continuous Pilot Ignition” or “Standing Pilot” as it is commonly known. IPI means “Intermittent Pilot Ignition”, which only initializes the pilot when you are going to be using the appliance.

### The difference between IPI and CPI:

**IPI (Intermittent Pilot Ignition) Mode:** is a fuel saving mode in which the pilot is only used when the main burner is on.

**CPI (Continuous Pilot Ignition) Mode:** The Pilot runs continuously even when the main burner is off.

## Installing the CPI Jumper Cable

1). Remove the Face Plate Front panel.

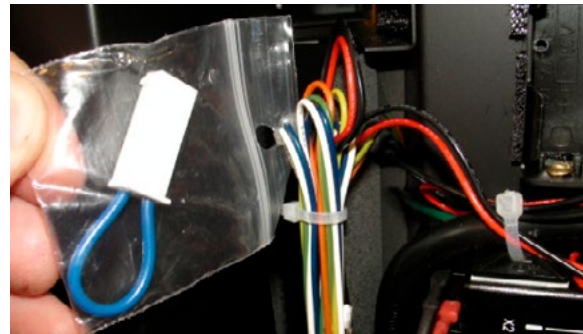

Figure 22.

2). Remove the bag containing the Jumper Cable from the plastic bag as shown. Remove the plastic bag from the unit.

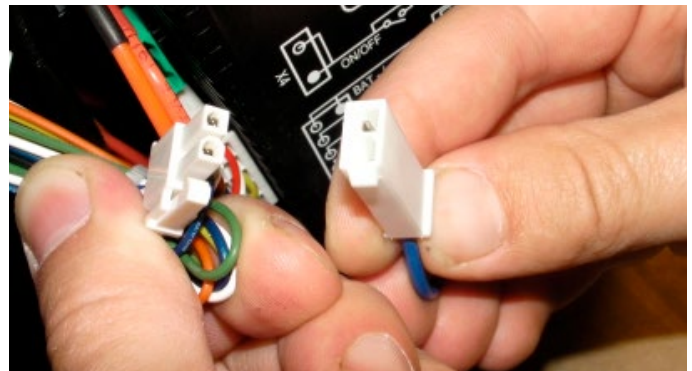

Figure 23.

3). Find the corresponding plug attached to the control wire harness.



Figure 24.

4). See operation section to turn remote into CPI mode.

# Proflame 2 System