



Household Use Only

Stainless Steel Food Jar

Model No. SW-FCE

INSTRUCTION MANUAL

Name of Each Part

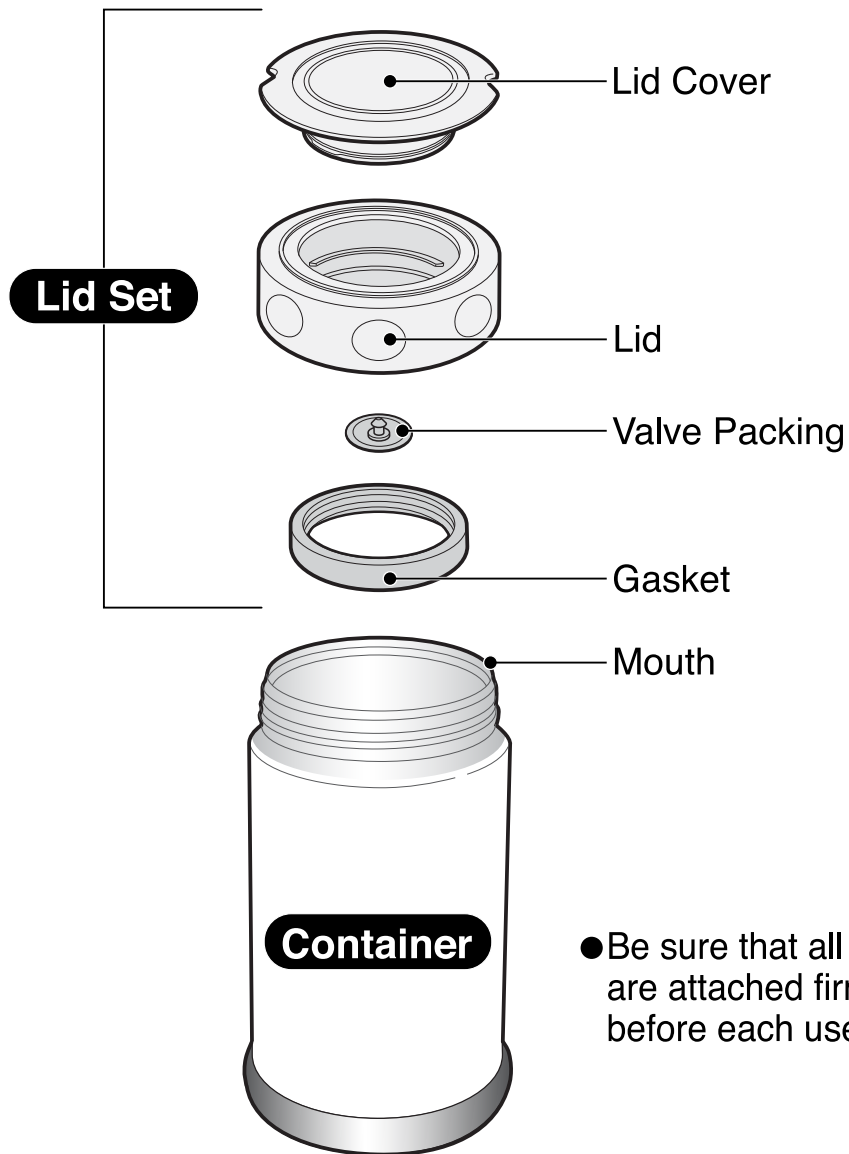

Please read before use. Keep these instructions for future references.

SW-FCE (E/K) / E

Important Safeguards:

Please follow these instructions to prevent scalding, deterioration and discoloration of foods and beverages, as well as malfunction and staining of the product.

Do not allow infants or small children to use this product. Keep out of the reach of infants and small children.
Mishandling may cause injury or scalding.

Due to its vacuum insulation, the outside of the product will not become hot, while hot foods and beverages will remain very hot for many hours. Please use caution when consuming.

Keep away from heat sources such as gas stoves, ovens and heaters.
Doing so may cause deformation or discoloration of the product.

Leave 1cm (1/2-inch) room on top when filling the Container.

Contents may overflow when placing the Lid Set.

Leave 1cm (1/2-inch) space

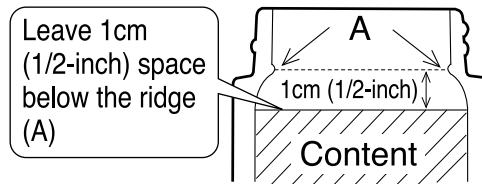

Do not leave the product on its side (contents may leak).

Do not heat the Container in a microwave.

Doing so may cause sparks and is dangerous. It may also cause deterioration or discoloration of the Container.

Please avoid filling the Container with the following:

- Dry ice and carbonated drinks: contents may leak out or the pressure may cause the Lid Set to burst, causing injuries.
- Fruit juice, raw foods, etc.: if left inside for a long period of time, contents may spoil and produce gas that may cause the contents to leak out or the Lid Set to burst, causing injuries.

Do not leave foods and beverages in the Container for an extended period of time.

Doing so may cause them to spoil, create gas that increases inner pressure, and cause the Lid Set to burst or the contents to leak out, causing injuries.

Always close the Lid Set tightly to prevent contents from leaking.

Hot foods and beverages may leak and cause scalding.

Always make sure the Gasket and Valve Packing are attached.

Using the product without the Gasket and Valve Packing may cause leaking and/or scalding.

Always clean the Container and Lid Set (Lid Cover, Lid, Gasket and Valve Packing) thoroughly immediately after use (see pg.8 "How to Take Care of Your Food Jar").

Not doing so may cause decay, mold, odor or discoloration. It may also cause leaks.

Important Safeguards: cont.

Please follow these instructions to prevent scalding, deterioration and discoloration of foods and beverages, as well as malfunction and staining of the product.

Do not use the product if it loses its heat retention properties.

The outside of the Container may become very hot if hot foods or beverages are placed inside.

This product is for holding foods and beverages and keeping them hot or cold. Please do not use for other than intended purposes.

Do not eat or drink out of the product while driving.

Doing so may cause scalding or may stain clothes or the interior of the car when spilled. Attempting to use while driving may also cause serious accidents.

Do not boil the Lid Set or Container to sanitize.

Doing so may cause deformation of the plastic or damage the stainless steel surface of the Container. Please see pg.8 "How to Take Care of Your Food Jar."

Do not use a dishwasher or dish-dryer to clean the Lid Set or Container.

Doing so may cause deformation, damage or rust to the product. Please see pg.8 "How to Take Care of Your Food Jar."

Cold soups or foods and beverages containing dairy must be heated before placing in the food jar to minimize spoiling.

Warnings and Cautions:

Avoid dropping or hitting against hard surfaces.

Damage to the plastic or stainless steel surface of the Container may reduce its ability to retain heat.

Do not allow hot kettles to touch the Mouth of the Container.

Doing so may tip the Container, causing scalds.

Consume foods and beverages within 6 hours to prevent from spoiling, and do not leave leftovers inside. Leftover contents may spoil.

Do not rub the design on the outside of the Container strongly.

It may come off.

Please refrain from storing foods and beverages high in salt. Please clean the Container and the Lid Set immediately after use.

Although the Container is made of stainless steel, salt may cause rust resulting in loss of thermal insulation. When storing foods and beverages with salt, avoid leaving them in for an extended period of time and clean the Container and Lid Set thoroughly immediately after use.

Warnings and Cautions: cont.

Do not carry by the Lid Set.

If the Lid Set is not on tightly, the Container may fall and cause injuries.

Do not force large ice cubes in. Crush ice into smaller pieces.

Doing so may cause deformation or damage to the product.

Do not attach parts other than those specifically for this product.

Doing so may cause leaks or breakage.

Placing hot foods or beverages may increase the pressure inside the Container, making the Lid Set difficult to remove. In this case, remove the Lid Cover, and use a small rounded object such as the back of a toothpick to push the Valve Packing (on the center of the Lid) through the hole to release the pressure (see illustration). Make sure not to tear the Valve Packing.

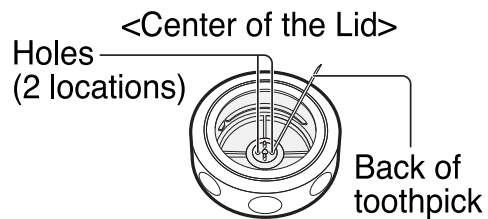

- Foods with strong odors or colors such as sauces, spinach and carrots should be wrapped in plastic wrap or foil before placing in the Container.

Contact with such foods may cause the odor or color to stain the interior.

- Please do not place any items directly on top of the Lid Set when the product contains hot food or beverage.

The heat may warm the item.

- Please close the Lid Set with the product standing upright after eating or drinking.
- Store the product upright when carrying inside bags to prevent contents from leaking.

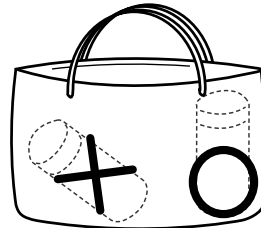

The rattling noise that may be heard when the product is shaken comes from the copper or aluminum foil in the vacuum insulation to increase heat (cold) retention and does not indicate a malfunction.

- The illustrations used in this instruction manual may vary from the actual product you have purchased.

How to Use:

- Wash the Lid Set and the interior of the Container thoroughly with warm water before use. Be sure that the Gasket and Valve Packing are attached properly to prevent foods and beverages from leaking.
- Attach the Lid Set properly and turn the product upside down to make sure contents do not leak.

1 Remove the Lid Set

- Remove the Lid Set (not the Lid Cover) by turning counterclockwise.

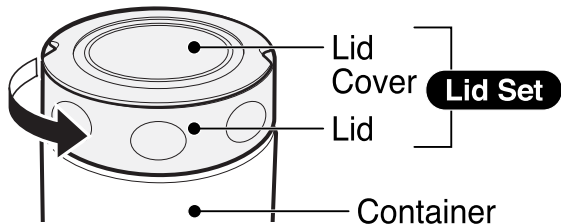

2 Preheat (Precool)

- ① For maximum temperature retention, fill with hot (cold) water for 1-2 minutes.
- ② After preheating (precooling), pour this water out and wipe.

3 Fill the Container

- Filling with too much food or beverage may cause them to overflow when closing the Lid Set. Leave 1cm (1/2-inch) room on top as illustrated when filling.

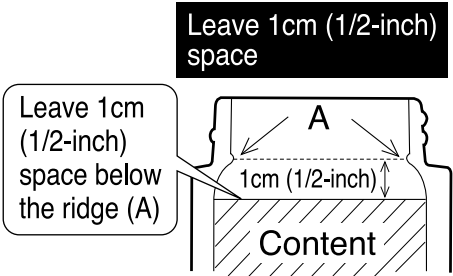

- If food or beverage is stuck on the area above A, wipe it clean before closing the Lid. (May leak after the Lid Set is closed.)

4 Close the Lid Set

- Turn the Lid Set clockwise to close.

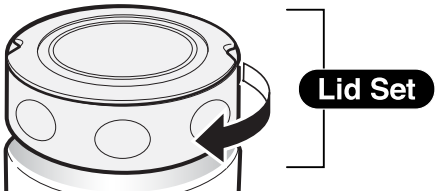

How to Disassemble and Assemble the Lid Set:

How to Disassemble the Lid Set:

1. Turn the Lid Cover counterclockwise to remove.

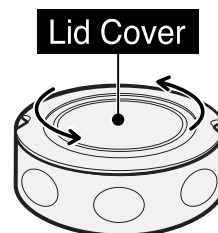

2. Pull the Gasket off with your fingers.

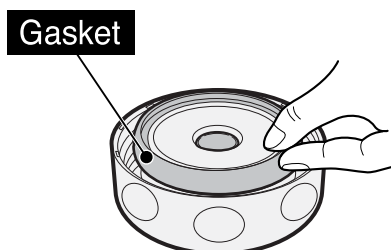

3. Pull the Valve Packing off with your fingers.

The Valve Packing is located on the center of the Lid.

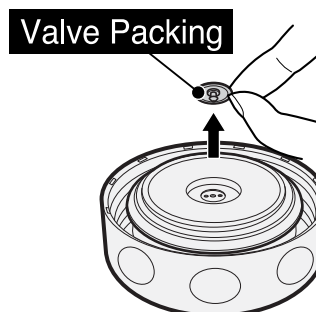

- The Lid Set has an open space for insulation. Remove the Lid Cover and clean the interior.

How to Assemble the Lid Set:

1. Attach the Gasket and Valve Packing to the Lid. (See pg.7 “How to Attach the Gasket” and “How to Attach the Valve Packing” for details.)

2. Turn the Lid Cover clockwise to attach.

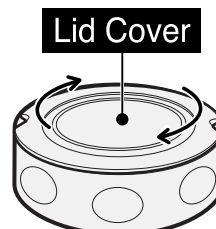

How to Disassemble and Assemble the Lid Set: cont.

How to Attach the Gasket:

1. Fit the Gasket to the Lid as illustrated.
2. Make sure the Gasket is fit all round.

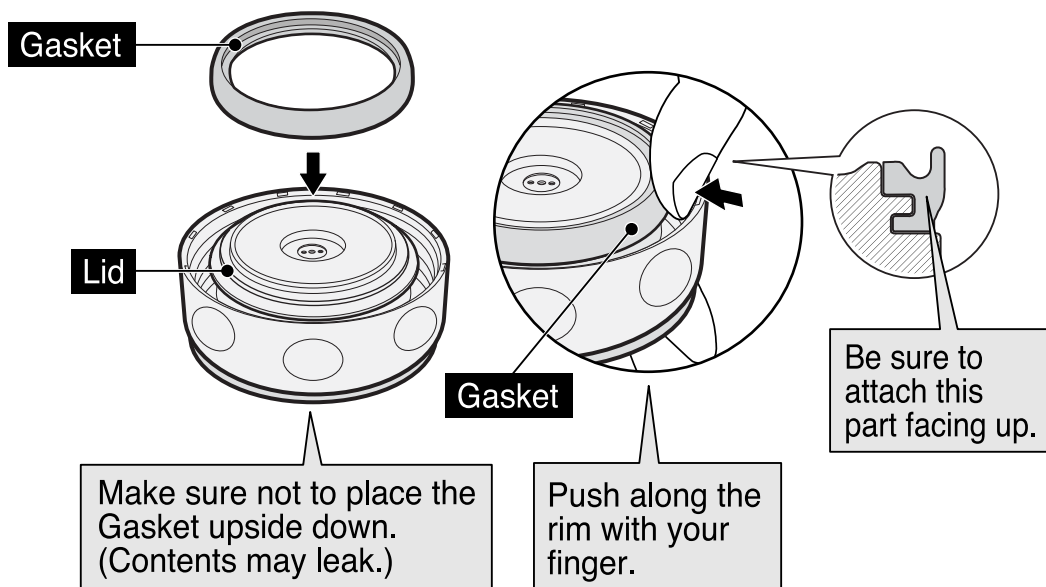

How to Attach the Valve Packing:

Fit the Valve Packing in the hole on the center of the Lid as illustrated. Make sure that the pointed part of the Valve Packing is protruding through the other side of the Lid.

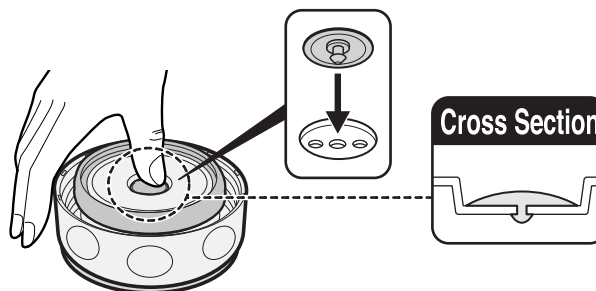

※ There are 3 holes at the center of the Lid. Please make sure to fit the Valve Packing in the center hole.

- Please replace the Valve Packing after cleaning.
- Please take caution not to scratch the Gasket and Valve Packing with your finger nails.

- After attaching the Gasket and the Valve Packing, make sure they are not twisted and that they are fitted tightly to prevent contents from leaking.

How to Take Care of Your Food Jar:

- Always clean all parts thoroughly after each use.

Outside of the Container	Wash with warm water and mild dishwashing liquid using a soft sponge. After rinsing, shake a few times and wipe dry.
Inside of the Container	Wash with warm water and mild dishwashing liquid using a soft sponge with handle. Be sure to rinse the interior thoroughly and dry. Always wash the inside thoroughly after each use to prevent odors from developing.
Lid Set (Lid Cover, Lid, Gasket and Valve Packing)	Wash with warm water and mild dishwashing liquid, rinse and wipe dry. <ul style="list-style-type: none"> ● Always disassemble the Lid Set when cleaning (see pg.6). ● Remove the Lid Cover when drying the Lid. ● Be sure to reassemble the Lid Set properly after cleaning to prevent contents from leaking.

- When storing for a long period of time, wash thoroughly with warm water, dry well and store in a cool, dry place to minimize damages.
- Dry thoroughly to prevent water stains or rusting of the product.
- The Container can be washed whole but do not soak for an extended period of time. (Water may get inside and become difficult to remove.)
- Do not use chlorine type bleach.
- Do not clean with thinner, benzene, abrasive cleaners or other harsh cleaners.
- Do not use a dishwasher or dish-dryer. Do not boil to sanitize (see pg.3).

How to Take Care of Your Food Jar: cont.

To Remove Rust Spots and Water Stains:

You may find rust spots or water stains caused by impurities in the water. To remove these stains, fill the Container with hot water with 10% vinegar and let stand for 30 minutes to an hour with the Lid Set open. Rinse and wash the interior (see pg.8 “How to Take Care of Your food Jar”).

For Odor Problems:

If the product is kept unwashed for a long period of time or is not cleaned thoroughly, it may smell or discolor. In this case, please follow these instructions:

Container and Lid Set

Wash thoroughly and dry with a soft cloth. Place in the sun and let dry for 1-2 hours.

Replacing the Valve Packing and Gasket

We take care in only using materials that are safe and hygienic for food contact. However, if plastic parts become damaged or its surface becomes rough, please replace them for optimum performance. The Valve Packing and Gasket may need to be replaced due to time and wear. Please check them about once a year. When replacing parts, please record the model number and part name beforehand. Then contact either the store where you purchased the product or Zojirushi Customer Service. Replacement parts may be available for an additional charge.